

Capacitive level probe - Type LEVELTEC S - L - LR



FEATURES

LEVELTEC S – Level Detection

- FOR LEVEL DETECTION OF LIQUID MEDIA, REGARDLESS OF CONDUCTIVITY
- FOAM AND CONDENSATE ARE NOT DETECTED
- SIMPLE PARAMETRISATION WITH TEACH-IN KEY
- APPLICABLE ALSO FOR PUMP PROTECTION
- VIBRATION-RESISTANT, UNIVERSALLY APPLICABLE

LEVELTEC L – Minimum Detection / LEVELTEC LR – Pump protection

- ESPECIALLY FOR LIMIT DETECTION WITH PASTY MEDIA AND STRONG ADHESIVE PRODUCT
- PRODUCT MONITORING IN PIPES / PUMP / DRY RUNNING PROTECTION
- INSENSITIVE TO FOAM
- ESPECIALLY FOR INSTALLATION IN PIPING (LEVELTEC LR)
- TEACH-IN KEY

DESCRIPTION

The level probes of type LEVELTEC are suitable for liquid media. Due to the capacitive measuring process, the LEVELTEC devices can reliably detect a wide range of conductive and non-conductive media.

The dielectric constant (D_c value) of the medium can easily be stored if the teach-in-key „HIGH“ in the level probe is briefly pressed. The LEVELTEC is factory-set to a D_c value of $\epsilon=25$. An even more exact detection of the switching status takes place if the Teach-In key “LOW” is pressed during the final assembly status without product medium. This has an advantage especially with low DK values.

The devices are designed for product media temperatures of 100°C continuous and 140°C (for max. exposure of 30 minutes). As an output signal, the level probes of type LEVELTEC are equipped with an active switch output with a maximum output current of 50mA. This can be connected directly to a PLC.

The LEVELTEC level probes are equipped with a G1/2” screw-in thread with elastomer-free sealing cone as a process connection. To enable adaption to the process, weld-in sockets and various adapters, e.g. for VARIVENT®, DIN11851 conical couplings etc. are available.

The probe tip, the only component in contact with the medium, is manufactured from FDA-compliant PEEK. The housing and the extension tube of the process connection are made of 1.4301 (304).

The LEVELTEC level probes with the NAM1FTP16 adapter socket, taking into account the medium conditions, provide a suitable alternative to level measurements based on the vibration principle.

The LEVELTEC L capacitive level probe is used specifically for low level (empty) detection at tank bottoms for pasty and adhesive media. The LEVELTEC LR capacitive level probe is used specifically for pump protection for pasty and adhesive media in pipes. Due to its construction of an inactive extension of the measuring pipe, the LEVELTEC L is insensitive to product deposits, thereby guaranteeing reliable detection. Due to the temperature resistance of the device, sterilisation and CIP cleaning can be performed.

The output signal can be connected directly to a PLC or PLS for further processing. The hygienic adaptation to the process is ensured by corresponding welded-in parts and flush-mounting. The adaptation to the D_k values of the respective media can be infinitely adjusted in the device.

Capacitive level probe

- Type LEVELTEC S - L - LR

TECHNICAL DATA

General details	
Device type/measuring principle	LEVELTEC / capacitive for detection of liquid media
Output	
Output signal	active, 50mA max. (PNP), short-circuit-proof
Switching function	Full/empty level indication specified by polarity of the auxiliary voltage, constant indication by 2-colour LED
Time delay	0.1 s non-adjustable
Electronics	
Version	Standard version, set to a dielectric constant (D_c value), factory setting $\epsilon=25$ Parametrised by pressing on teach-in key „HIGH“ (3...4 seconds) in the device, probe must be covered
Auxiliary energy resources	
Supply voltage	12...36 V DC, max. 45 mA (bei 24 V DC) without switching load
Immunity to interference	CE-conformity is fulfilled
Conditions of use	
Installation position	see installation instructions
Setting	Press and hold teach-in „HIGH“ key for approx. 3 seconds; probe must be covered when settings are created Press teach-in key "LOW" for approx. 3 seconds. Probe should be covered by adhesives.
Medium temperature	-20...+100°C, short duration 140°C for max. 30 min
Ambient storage temperature	-20...+65°C
Max. operating pressure	10bar (with TEM1FTP16 weld-in socket)
Protection class acc. to EN60529	IP 67 and IP 69K with M12-plug and mating plug
Construction	
Electrical connection	M16x1.5 cable screw connection – nickel-plated brass, or M12x1 plug-in connector, nickel-plated brass (stainless steel available on request)
Tightening torque	max. 5-10Nm (during initial assembly)
Process connection	- G1/2" with elastomer-free sealing cone (TP16)
Materials	- Field housing / lid: CrNiSt 1.4301 (304) - Housing seal: FKM - Process connection/extension tube: CrNiSt 1.4305 - Messspitze: PEEK
Accessories	
Process connection adapter	see ordering information

ELECTRIC CONNECTION

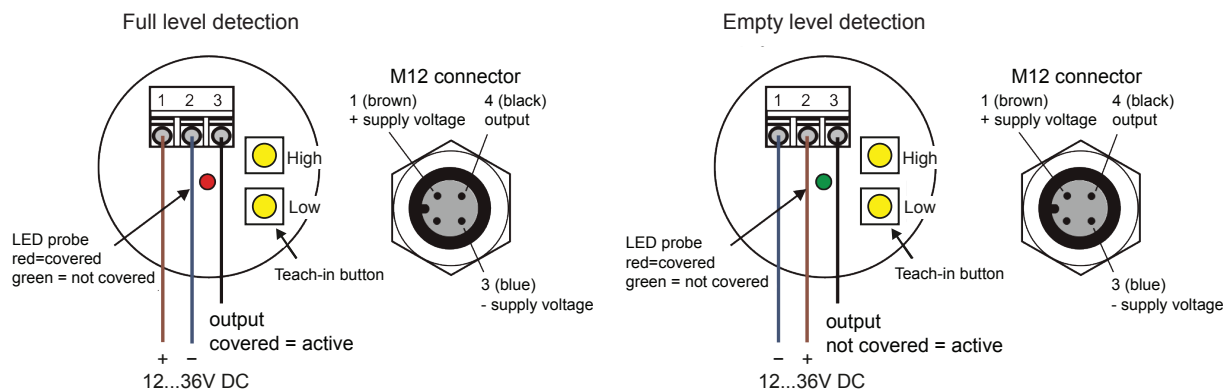

Medium	D_c - value (approx.)
Water	81
Methanol	33
Brew	25
Ketchup	24
Cream (skin)	19
Ice cream (-20°C)	17
Acetic acid	6
Butter	6
Chocolate	3
Vegetable oil	2

Capacitive level probe - Type LEVELTEC S - L - LR

DIMENSIONAL DRAWINGS (dimensions in mm)

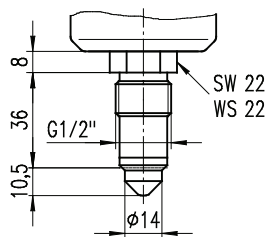
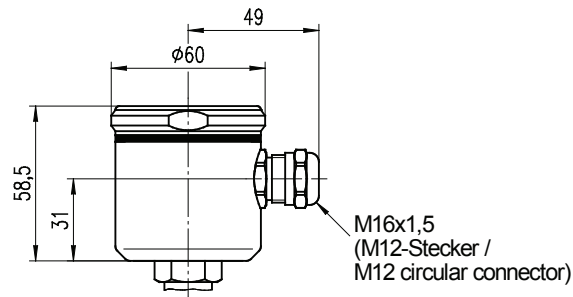

LEVELTEC S

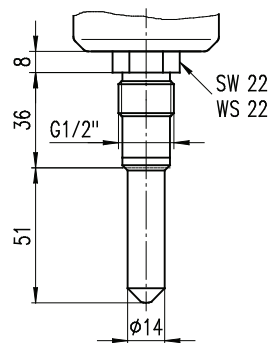

LEVELTEC L

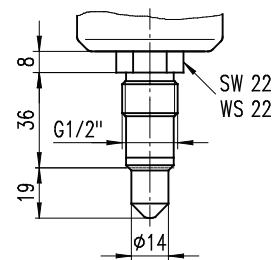

LEVELTEC LR

Prozessanschlussadapter: (weitere Ausführungen auf Anfrage)
adapters for process connections: (other constructions on request)

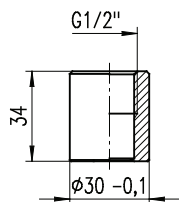

Z-TEM1FTP16
Einschweißmuffe
für Tank
welding socket
for tank

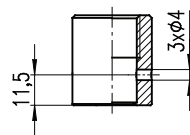

Z-TEM1LTP16
Einschweißmuffe
mit Leckagebohrungen
welding socket
with leakage holes

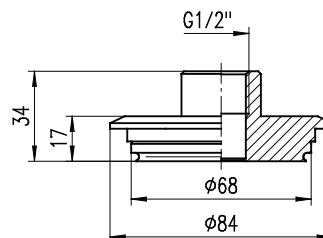

Z-TVA6FTP16
VARIVENT-Flansch Ø68
VARIVENT-flange Ø68

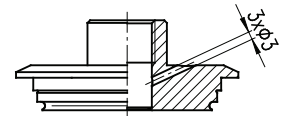

Z-TVA6LTP16
VARIVENT-Flansch Ø68
mit Leckagebohrungen
VARIVENT-flange Ø68
with leakage holes

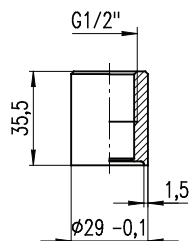

Z-TEM4FTP16
Einschweißmuffe
für Rohr
welding socket
for pipe

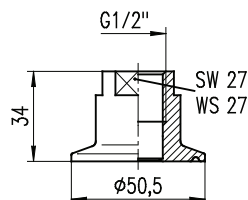

Z-TCL4FTP16
Clamp DIN 32676
DN25-40

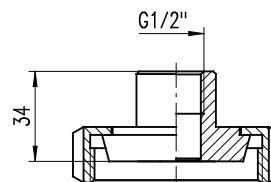

Z-TMN...FTP16
Kegelstutzen DIN 11851
conical nozzle DIN 11851
DN25, DN40, DN50

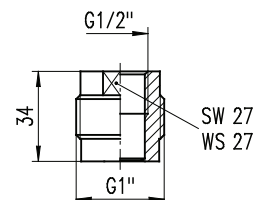

Z-NAM1FTP16
Adaptermuffe L
adapter socket L

Capacitive level probe - Type LEVELTEC S - L - LR

INSTALLATION INSTRUCTIONS

Due to their high flexibility and short installation lengths, the level probes of type LEVELTEC are suitable both for applications in metallic tanks, for empty or full level indication, as well as for use in metallic pipes, e. g. as pump protection. During assembly, it is essential to ensure a flawless electrically conductive connection between LEVELTEC and tank or pipe. Do not use insulating material such as Teflon tape! To guarantee reliable detection in pipes, the LEVELTEC level probes should not be installed at 12 or 6 o'clock.

The sensor tips made in PEEK are sensitive to mechanical influences. Therefore, it is important to take extreme care when installing these parts. Mechanically damaged parts are not covered by the warranty. Furthermore, a minimum distance of 0.5 m must be maintained during cleaning with high-pressure and jet spray cleaning devices.

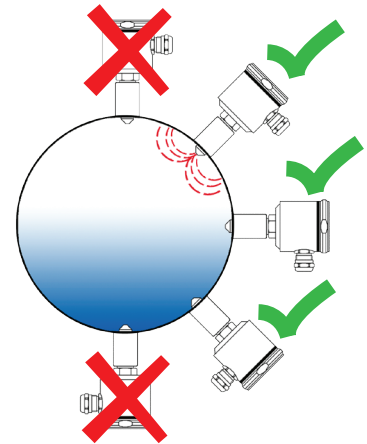

ORDERING INFORMATION for LEVELTEC S - L - LR

LEVELTEC Type	S
	L
	LR
Design	SB Standard version
Electrical connection	C M16x1.5 cable screw connection
	M M12x1 round plug-in connector
Installation length (inactiv)	A only for Leveltec L and LR

LEVELTEC				
-----------------	--	--	--	--

ORDERING EXAMPLES

LEVELTEC Type S with cable screw connection M16x1,5 LEVELTEC S_SBC
 LEVELTEC Type LR with M12 connector LEVELTEC LR_SBMA
 LEVELTEC Type L with cable screw connection M16x1,5 LEVELTEC L_SBCA

ORDERING INFORMATION for accessories LEVELTEC S - L - LR

Process connection adapter (please order separately)	Article number
Weld-in socket Ø 30 mm, 1.4404 (AISI 316L)	Z-TEM1FTP16
Weld-in socket Ø 30 mm, with leakage holes Ø 3 mm, 1.4404 (AISI 316L)	Z-TEM1LTP16
VARIVENT® flange Ø 68 mm, DN40-125/PN40, 1.4404 (AISI 316L)	Z-TVA6FTP16
VARIVENT® flange Ø 68 mm, DN40-125/PN40, with leakage holes, 1.4404 (AISI 316L)	Z-TVA6LTP16
Conical couplings with groove union nut DIN 11851, DN25/PN40, 1.4404 (AISI 316L)	Z-TMN2FTP16
Conical couplings with groove union nut DIN 11851, DN40/PN40, 1.4404 (AISI 316L)	Z-TMN4FTP16
Conical couplings with groove union nut DIN 11851, DN50/PN25, 1.4404 (AISI 316L)	Z-TMN5FTP16
Adapter socket for fitting in internal thread G1", 1.4404 (AISI 316L)	Z-NAM1FTP16
Weld-in dummy MS58	Z-TED1FTP16
Clamp DN40/DN50 (1½", 2"), 1.4404 (AISI 316L)	Z-TCL4FTP16
Clamp DN40/DN50 (1½", 2"), 1.4404 (AISI 316L)	Z-TCL5FTP16
Sealing plug, 1.4404 (AISI 316L)	Z-TVS1FTP16

Please observe the permissible nominal pressure of the process connection selected.
 All specifications and certifications specified are only guaranteed when Hengesbach original components are used.
 Our devices are subject to constant development; subject to technical modification.